



**INSAUSTI**®

DESIGN / BUILD / INNOVATE  
DISEÑAR / CONSTRUIR / INNOVAR

# GENERAL CATALOGUE CATÁLOGO GENERAL



**strack** Patienten-  
und Pflegebedarf







# 30 YEAR SERVICE LIFE AÑOS DE VIDA ÚTIL



## DESIGN

All products are designed at our factory in Pamplona  
Our design guidelines are functionality, ergonomics, asepsis, a tasteful design

## BUILD

The components used are mainly manufactured in Spain and Germany  
We cooperate with a network of approximately 60 suppliers  
The components designed by Insausti technical office are manufactured in suppliers production plants  
All trolleys and accessories are assembled upon request at our factory in Pamplona

## INNOVATE

Insausti products are developed for health professionals who think long-term and wish to offer their patients an excellent human and technical service

## DISEÑAR

Todos los productos se diseñan en nuestra fábrica de Pamplona  
Las pautas de diseño son funcionalidad, ergonomía, asepsia, cuidado de la estética

## CONSTRUIR

Los componentes utilizados se fabrican principalmente en España y Alemania  
Colaboramos con una red de 60 proveedores aproximadamente  
Los componentes diseñados en la oficina técnica de Insausti se fabrican en las plantas de producción de los proveedores  
Todos los carros y los accesorios se ensamblan bajo pedido en nuestra fábrica de Pamplona

## INNOVAR

Los productos de Insausti se desarrollan para los profesionales de la salud que piensan a largo plazo, que desean ofrecer a los pacientes un servicio humano y técnico excelente

## INDEX ÍNDICE

<b>1 - TECHNICAL FEATURES</b>	<b>CARACTERÍSTICAS TÉCNICAS</b>	<b>6</b>
<b>2 - MEDICAL TROLLEYS</b>	<b>CARROS MÉDICOS</b>	
<b>LOW TROLLEYS</b>	<b>CARROS BAJOS</b>	<b>16</b>
<b>MULTIFUNCTION</b>	<b>MULTIFUNCIÓN</b>	
<b>SQS</b>		<b>18</b>
<b>300 SERIES</b>	<b>SERIE</b>	<b>22</b>
<b>ANAESTHESIA</b>	<b>ANESTESIA</b>	
<b>SQS</b>		<b>30</b>
<b>300 SERIES</b>	<b>SERIE</b>	<b>31</b>
<b>MRI</b>		<b>34</b>
<b>DIFFICULT INTUBATION / ISOLATION</b>	<b>INTUBACIÓN DIFÍCIL / AISLAMIENTO</b>	<b>36</b>
<b>PLASTER TROLLEY</b>	<b>CARRO DE YESOS</b>	<b>37</b>
<b>EMERGENCY</b>	<b>EMERGENCIA</b>	
<b>SQM</b>		<b>40</b>
<b>PAEDIATRIC</b>	<b>PEDIÁTRICA</b>	<b>42</b>
<b>100 SERIES</b>	<b>SERIE</b>	<b>43</b>
<b>TREATMENT</b>	<b>CURAS</b>	
<b>SQM</b>		<b>48</b>
<b>100 SERIES</b>	<b>SERIE</b>	<b>50</b>
<b>TRANSPORT T. WITH CASSETTES</b>	<b>C. DE TRANSPORTE CON CASETES</b>	<b>58</b>
<b>UNIT DOSE MEDICATION</b>	<b>MEDICACIÓN UNIDOSIS</b>	<b>62</b>
<b>TRANSPORT</b>	<b>TRANSPORTE</b>	<b>68</b>
<b>STORAGE FURNITURE</b>	<b>MOBILIARIO DE ALMACÉN</b>	<b>74</b>
<b>3 - BASIC TROLLEYS</b>	<b>CARROS BÁSICOS</b>	
<b>SQUARE TROLLEYS</b>	<b>CARROS CUADRADOS SQS</b>	<b>77</b>
<b>SIMPLE TROLLEYS</b>	<b>CARROS SIMPLES 300</b>	<b>78</b>
<b>DOUBLE TROLLEYS</b>	<b>CARROS DOBLES 300</b>	<b>80</b>
<b>LOW TROLLEYS</b>	<b>CARROS BAJOS</b>	<b>82</b>
<b>SQUARE TROLLEYS</b>	<b>CARROS CUADRADOS SQM</b>	<b>84</b>
<b>SIMPLE TROLLEYS</b>	<b>CARROS SIMPLES 100</b>	<b>85</b>
<b>4 - ACCESSORIES</b>	<b>ACCESORIOS</b>	<b>86</b>

**TECHNICAL FEATURES CARACTERÍSTICAS TÉCNICAS**

**SQUARE TROLLEY CARRO CUADRADO** **CE**

~~ISO~~  
**480 x 480 mm**



Prepared for elevated accessories  
Preparado para accesorios elevados

Monobloc structure of AISI-304  
stainless steel  
Union with rivets and TIG welding

Estructura monobloque de acero  
inoxidable AISI-304  
Unión con remaches y soldadura TIG

Ergonomic handle  
Asa ergonómica

Total opening  
Steel ball-bearing slides  
with retention system, 20 kg

Apertura total  
Correderas de bolas de  
acero con sistema de  
retención, 20 kg



Front stop  
It protects the slide against  
strong impacts when closing

Tope frontal  
Protege la corredera contra  
fuertes impactos de cierre

Prepared for ref. 32R, 37R, 50, 51, 57  
Preparado para ref. 32R, 37R, 50, 51, 57

**TECHNICAL FEATURES CARACTERÍSTICAS TÉCNICAS**

**SIMPLE TROLLEY CARRO SIMPLE** **CE**  
**DOUBLE TROLLEY CARRO DOBLE** **CE**

**ISO**  
**640 x 480 mm**  
**900 x 630 mm**



600 x 400 mm ISO drawers  
 Cajones ISO 600 x 400 mm



Prepared for elevated accessories  
 Preparado para accesorios elevados



Monobloc structure of AISI-304 stainless steel  
 Union with rivets and TIG welding  
 Estructura monobloque de acero inoxidable AISI-304  
 Unión con remaches y soldadura TIG

Ergonomic handle  
 Asa ergonómica

Total opening  
 Steel ball-bearing slides with retention system, 20 kg

Apertura total  
 Correderas de bolas de acero con sistema de retención, 20 kg

Front stop  
 It protects the slide against strong impacts when closing

Topo frontal  
 Protege la corredera contra fuertes impactos de cierre

Prepared for ref. 32L, 37L, 32NL, 37NL  
 Preparado para ref. 32L, 37L, 32NL, 37NL



**TECHNICAL FEATURES CARACTERÍSTICAS TÉCNICAS**

**SQUARE TROLLEY CARRO CUADRADO**

~~ISO~~ 480 x 480 mm

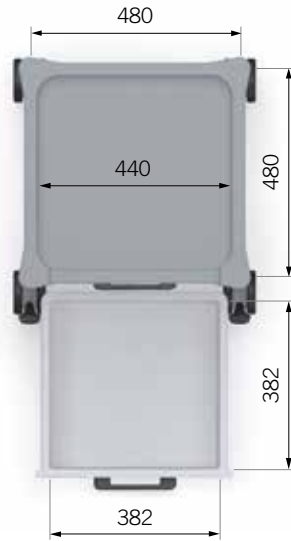

**SQS**



**SQM**



**DOUBLE TROLLEY CARRO DOBLE**

**ISO** 900 x 630 mm

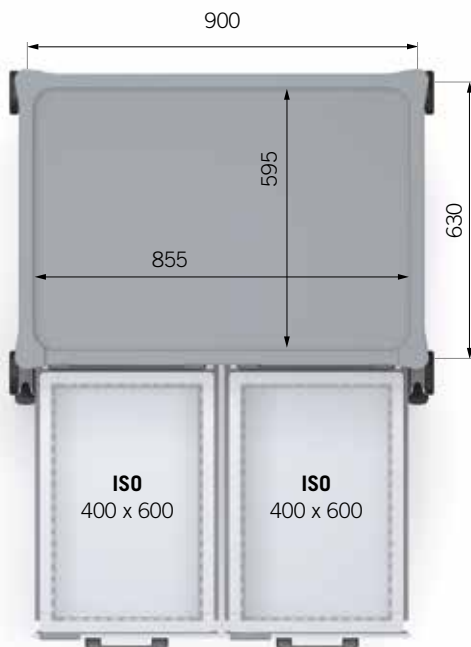

**300 SERIES SERIE**

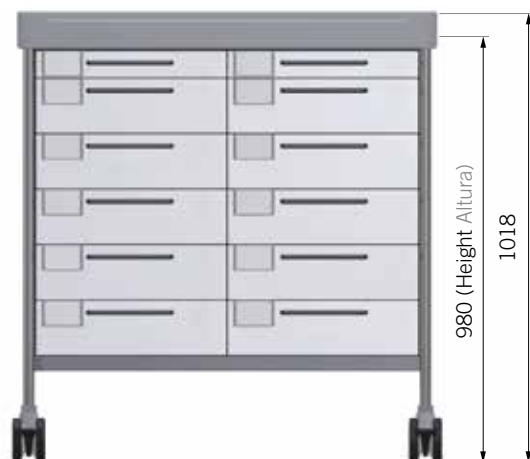

**TECHNICAL FEATURES CARACTERÍSTICAS TÉCNICAS**

**SIMPLE TROLLEY CARRO SIMPLE**

**ISO 640 x 480 mm**

ISO International Organization for Standardisation, ISO norm 3394  
 600 x 400 mm ISO drawers. Standard, interchangeable with hospital ISO furniture

ISO Organización Internacional de Normalización, norma ISO 3394  
 Cajones ISO 600 x 400 mm. Estándar, intercambiables con el mobiliario ISO del hospital



**LOW BAJO**



**300 SERIES SERIE**



**100 SERIES SERIE**

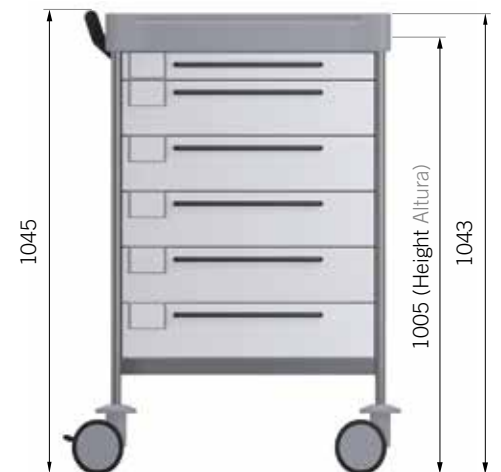

## TECHNICAL FEATURES CARACTERÍSTICAS TÉCNICAS

### **STATIC TROLLEYS** **SQS, 300 SERIES**

- The work surface design allows you to move the trolley without needing the push handle
- Ø 100 mm wheels
- 2 antistatic, 2 with brake at the front part

### **CARROS ESTÁTICOS** **SQS, SERIE 300**

- El diseño de la superficie de trabajo permite manejar el carro sin necesidad de tirador
- Ruedas Ø 100 mm
- 2 antiestáticas, 2 con freno parte frontal

### **EXTENSIVE MOBILITY TROLLEYS** **SQM, 100 SERIES**

- Elevated push handle left side
- Bumpers for hits
- Ø 125 mm wheels
- 2 antistatic, 2 with brake at left side
- High-tech wheels

### **CARROS ALTA MOVILIDAD** **SQM, SERIE 100**

- Tirador elevado lado izquierdo
- Protectores paragolpes
- Ruedas Ø 125 mm
- 2 antiestáticas, 2 con freno lado izquierdo
- Ruedas de alta tecnología

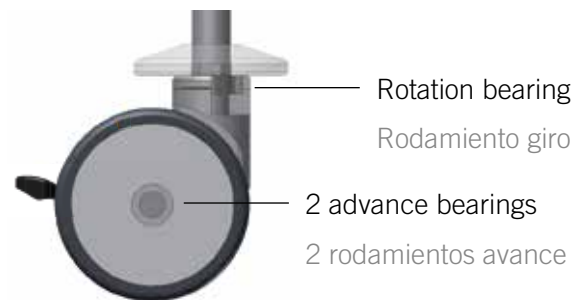

**TECHNICAL FEATURES CARACTERÍSTICAS TÉCNICAS**

**STORAGE FURNITURE MOBILIARIO DE ALMACÉN  
700 SERIES SERIE**

**ISO  
640 x 480 mm**



**STATIC TROLLEYS**

**CARROS ESTÁTICOS**



- Monobloc structure of AISI-304 stainless steel  
Unión con remaches y soldadura TIG
- Phenolic doors with key locking
- Ø 100 mm wheels  
2 antistatic, 2 with brake at the front part
- Estructura monobloque de acero inoxidable AISI-304  
Unión con remaches y soldadura TIG
- Puertas de fenólico con bloqueo de llave
- Ruedas Ø 100 mm  
2 antiestáticas, 2 con freno parte frontal

**TRANSPORT TRANSPORTE  
600 SERIES SERIE**

**ISO  
640 x 480 mm  
900 x 630 mm**



**EXTENSIVE MOBILITY TROLLEYS**

**CARROS ALTA MOVILIDAD**



- Monobloc structure of AISI-304 stainless steel  
Unión con remaches y soldadura TIG
- Phenolic doors with key locking
- Vertical handles, both sides
- Ø 125 mm wheels  
2 antistatic, 2 with dual lock at the right side
- Estructura monobloque de acero inoxidable AISI-304  
Unión con remaches y soldadura TIG
- Puertas de fenólico con bloqueo de llave
- Asas verticales, ambos lados
- Ruedas Ø 125 mm  
2 antiestáticas, 2 con doble bloqueo lado derecho



**Fixed wheel**

Rueda fija



**Swivel wheel**

Rueda giratoria



**Locked wheel**

Rueda bloqueada

## **TECHNICAL FEATURES CARACTERÍSTICAS TÉCNICAS**

### **PE, PP**

Withstand disinfectants for the elimination of pathogens

Withstand 100% pure alcohol (not diluted), bleach, detergent, soap solutions, oils, polish, aqueous ammonia, chlorhexidine

Withstand constant cleaning protocols, they do not degrade

Resisten los desinfectantes para la eliminación de los agentes patógenos

Resisten alcohol puro 100% (sin diluir), lejía, detergente, soluciones jabonosas, aceites, grasas, amoníaco acuoso, clorhexidina

Resisten protocolos de limpieza constantes, no se degradan

### **PE, POLYETHYLENE WORK SURFACE SUPERFICIE DE TRABAJO DE POLIETILENO**

Protection on all 4 sides

Protección en los 4 lados



### **PP, POLYPROPYLENE SQUARE DRAWERS CAJONES CUADRADOS DE POLIPROPILENO**

Drawers made in a single piece

Cajones fabricados en una única pieza



**TECHNICAL FEATURES CARACTERÍSTICAS TÉCNICAS**

**SQUARE TROLLEY CARRO CUADRADO**

Drawer colour Colores de cajones



**W** White Blanco



**B** Blue Azul



**R** Red Rojo

**SIMPLE TROLLEY / DOUBLE TROLLEY CARRO SIMPLE / CARRO DOBLE**

Front drawer colour Colores de frentes de cajón



**W** White Blanco



**B** Blue Azul



**F** Lilac Lila



**G** Green Verde



**Y** Yellow Amarillo



**R** Red Rojo

**500 / 600 / 700 SERIES SERIE**

Door colour Color de puertas



**DN** Light grey Gris claro

## TECHNICAL FEATURES CARACTERÍSTICAS TÉCNICAS

### CARD HOLDER PORTATARJETAS

**PATENTED PATENTADO**



**HC**

### WHITE CARDS TARJETAS BLANCAS

Plastic material

ISO norm 7810 identification card, international standard

Material plástico

Tarjeta de identificación norma ISO 7810, estándar internacional

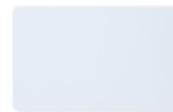

**CW**

### SIMPLE TROLLEY CARRO SIMPLE

Each drawer includes as standard one card holder and one white card

Cada cajón incluye de serie un portatarjetas y una tarjeta blanca

**INCLUDED INCLUIDAS**



**OPTIONAL OPCIONAL**

**INCLUDED INCLUIDAS**



**OPTIONAL OPCIONAL**

## TECHNICAL FEATURES CARACTERÍSTICAS TÉCNICAS

### COLOUR CARDS (optional) TARJETAS DE COLORES (opcional)



**CR** Red Rojo



**CF** Lilac Lila



**CY** Yellow Amarillo



**CG** Green Verde



**CB** Blue Azul



**CP** Pink Rosa



**CO** Orange Naranja



**CN** Grey Gris

### DOUBLE TROLLEY CARRO DOBLE

Each drawer includes as standard one card holder and one white card

Cada cajón incluye de serie un portatarjetas y una tarjeta blanca





**LOW TROLLEYS, REDUCED HEIGHT**

**CARROS BAJOS, ALTURA REDUCIDA** **CE**

~~ISO~~

**480 x 480 mm**

**GYNECOLOGY, TRAUMATOLOGY, DIAGNOSIS, DRESSING, INJECTIONS, OUTPATIENTS CLINICS**

**GINECOLOGÍA, TRAUMATOLOGÍA, DIAGNÓSTICO, VENDAJES, EXTRACCIONES, CONSULTAS EXTERNAS**



**STATIC TROLLEYS**

**CARROS ESTÁTICOS**



**Q002LW B**  
SQ061M4LW B.26LW(R1Q)

## LOW TROLLEYS, REDUCED HEIGHT CARROS BAJOS, ALTURA REDUCIDA **CE**



To store it under 900 mm work tables  
For users working in sitting position

Para guardarlos debajo de mesas de trabajo de 900 mm  
Para el usuario que trabaja en posición sentada

~~ISO~~  
**480 x 480 mm**



**Q001LW B**  
SQ061M4LW B.32R



**Q003LW W**  
SQ061M4LW W.26LW(R1Q).30.33L



**Q004LW W**  
SQ061M4LW W.26(RA4Q.A5).32R

**ISO**  
**640 x 480 mm**



**3100LW W**  
362M5LW W.32R



**3103LW B**  
362M5LW B.32L.33R.50



**3105LW G**  
362M5LW G.26(RA4.A5).32R

**MULTIFUNCTION MULTIFUNCIÓN**  
**SQS CE**

~~ISO~~  
**480 x 480 mm**

ICU, CARDIOLOGY, TRAUMATOLOGY, DIAGNOSIS, DRESSING, INJECTIONS, OUTPATIENTS CLINICS

UCI, CARDIOLOGÍA, TRAUMATOLOGÍA, DIAGNÓSTICO, VENDAJES, EXTRACCIONES, CONSULTAS EXTERNAS



**STATIC TROLLEYS**  
**CARROS ESTÁTICOS**



**Q024 W**  
SQ021 W.26LW(R1Q)

**CENTRAL SUPPORT**  
**SOPORTE CENTRAL**



**R1Q**

**BIN (Optional)**  
**CUBO (Opcional)**



**50 - 13 LITRES LITROS**  
**51 - 26 LITRES LITROS**

**MULTIFUNCTION MULTIFUNCIÓN**  
**SQS CE**

~~ISO~~  
**480 x 480 mm**

ICU, CARDIOLOGY, TRAUMATOLOGY, DIAGNOSIS, DRESSING, INJECTIONS, OUTPATIENTS CLINICS

UCI, CARDIOLOGÍA, TRAUMATOLOGÍA, DIAGNÓSTICO, VENDAJES, EXTRACCIONES, CONSULTAS EXTERNAS



**STATIC TROLLEYS**  
**CARROS ESTÁTICOS**



**Q068 B**  
 SQ061 B.26(R2Q.R1Q).33R.46.50

**CENTRAL SHELF**  
**ESTANTE CENTRAL**



**R2Q**

**CENTRAL SUPPORT**  
**SOPORTE CENTRAL**



**R1Q**



Contaminated waste on  
 right side

Desechos contaminados  
 en lado derecho

**MULTIFUNCTION MULTIFUNCIÓN**  
**SQS CE**

~~ISO~~

**480 x 480 mm**

ICU, CARDIOLOGY, TRAUMATOLOGY, DIAGNOSIS, DRESSING, INJECTIONS, OUTPATIENTS CLINICS

UCI, CARDIOLOGÍA, TRAUMATOLOGÍA, DIAGNÓSTICO, VENDAJES, EXTRACCIONES, CONSULTAS EXTERNAS



**STATIC TROLLEYS**  
**CARROS ESTÁTICOS**



**3 GLOVE BOX HOLDER (Optional)**  
**SOPORTE 3 CAJAS DE GANTES**  
**(Optional)**



**46**

**BIN (Optional)**  
**CUBO (Opcional)**



**50 - 13 LITRES LITROS**  
**51 - 26 LITRES LITROS**

**Q092 W.(6)CP**  
**SQ061 W.26(RA5Q.A5.R1Q).30.33L.(6)CP**

**MULTIFUNCTION MULTIFUNCIÓN**  
**SQS CE**

~~ISO~~  
**480 x 480 mm**



**STATIC TROLLEYS**  
**CARROS ESTÁTICOS**



**Q025 W**  
 SQ022 W.32R



**Q027 B**  
 SQ021TXQ B.26M(R75QM)



**Q054 B**  
 SQ061 B.32R



**Q058 B**  
 SQ061 B.32R.46



**Q063 W**  
 SQ061 W.32L.33R.50



**Q064 W**  
 SQ061 W.26(RA4Q.A5).32L.33R.50



**Q072 B**  
 SQ061 B.30.32L



**Q077 W**  
 SQ061 W.26LW(R1Q).30.33L



**Q091 W**  
 SQ061 W.26(RA4Q.A5).32R

**MULTIFUNCTION MULTIFUNCIÓN**  
**300 SERIES SERIE** 

**ISO**  
**640 x 480 mm**

ICU, CARDIOLOGY, TRAUMATOLOGY, DIAGNOSIS, DRESSING, INJECTIONS, OUTPATIENTS CLINICS

UCI, CARDIOLOGÍA, TRAUMATOLOGÍA, DIAGNÓSTICO, VENDAJES, EXTRACCIONES, CONSULTAS EXTERNAS



**STATIC TROLLEYS**  
**CARROS ESTÁTICOS**



**CENTRAL SHELF**  
**ESTANTE CENTRAL**



**R2**



Contaminated waste on  
right side

Desechos contaminados  
en lado derecho

**3132 W**  
365 W.26LW(R2).32L.33R.50

**MULTIFUNCTION MULTIFUNCIÓN**  
**300 SERIES SERIE** **CE**

**ISO**  
**640 x 480 mm**

ICU, CARDIOLOGY, TRAUMATOLOGY, DIAGNOSIS, DRESSING, INJECTIONS, OUTPATIENTS CLINICS

UCI, CARDIOLOGÍA, TRAUMATOLOGÍA, DIAGNÓSTICO, VENDAJES, EXTRACCIONES, CONSULTAS EXTERNAS



**STATIC TROLLEYS**  
**CARROS ESTÁTICOS**



**CENTRAL SUPPORT**  
**SOPORTE CENTRAL**



**R1**

**3133 F**  
 365 F.26LW(R1).46.50



**MULTIFUNCTION MULTIFUNCIÓN**  
**300 SERIES SERIE** **CE**

**ISO**  
**640 x 480 mm**

ICU, CARDIOLOGY, TRAUMATOLOGY, DIAGNOSIS, DRESSING, INJECTIONS, OUTPATIENTS CLINICS

UCI, CARDIOLOGÍA, TRAUMATOLOGÍA, DIAGNÓSTICO, VENDAJES, EXTRACCIONES, CONSULTAS EXTERNAS



**STATIC TROLLEYS**  
**CARROS ESTÁTICOS**

**COMPUTER MEDICAL TROLLEY**

**CARRO MÉDICO PARA ORDENADOR**



**3180 Y**  
362M6TX Y.26M(R75M)

**VESA MONITOR SUPPORT**  
**SOPORTE PARA MONITOR VESA**



**26M(R75M)**  
3 Positions, adjustable  
3 Posiciones, regulable

**CABLE LEAD THROUGH**  
**PASACABLES**



**KEYBOARD DRAWER**  
**CAJÓN PARA TECLADO**



**MULTIFUNCTION MULTIFUNCIÓN**  
**300 SERIES SERIE** 

**ISO**  
**640 x 480 mm**



**STATIC TROLLEYS**  
**CARROS ESTÁTICOS**



**3102 B**  
 322 B.32R



**3105 Y**  
 332 Y.26LW(R1)



**3174 G**  
 332TX G.26M(R75M)



**3129 W**  
 365 W.32R



**3127 F**  
 365 F.32R.46



**3131 W**  
 365 W.30.32L



**3151 B**  
 365 B.26LW(R1).33R.50



**3140 F**  
 365 F.26LW(R1).30.46.50



**3145 G**  
 365 G.26(RA5.A5.R1).32R

**MULTIFUNCTION MULTIFUNCIÓN**  
**300 SERIES SERIE** 

**ISO**  
**900 x 630 mm**

**TRAUMATOLOGY, DRESSING, SURGERY**  
**TRAUMATOLOGÍA, VENDAJES, CIRUGÍA**



**STATIC TROLLEYS**  
**CARROS ESTÁTICOS**



**3826 B**  
N365 B.26LW(R2N).32NR



**3800 G**  
N322 G.26LW(R1N)



**3818 F**  
N365 F.26LW(R1N)



**3830 Y**  
N365 Y.26(R2N.R1N)

**MULTIFUNCTION MULTIFUNCIÓN**  
**300 SERIES SERIE** 

**ISO**  
**900 x 630 mm**

**TRAUMATOLOGY, DRESSING, SURGERY**  
**TRAUMATOLOGÍA, VENDAJES, CIRUGÍA**



**STATIC TROLLEYS**  
**CARROS ESTÁTICOS**



**ANAESTHESIA ANESTESIA**

**3956 G**  
 N365 G.26(RA4N.A5.R2N).32NR



**3840 W**  
 N365 W.26(R7N.R7N).32NR



**3934 B**  
 N365 B.26(RA4N.A5).(2)32NR.33L



**3942 W**  
 N365 W.26(RA5N.A5.R1N)

# ANAESTHESIA ANESTESIA



# ANAESTHESIA ANESTESIA



**ANAESTHESIA ANESTESIA**

**SQS CE**

~~ISO~~

**480 x 480 mm**

**EMERGENCY ROOM, OPERATING ROOM, REANIMATION AREA**

**SERVICIO URGENCIAS, QUIRÓFANO, URPA**



**STATIC TROLLEYS**  
**CARROS ESTÁTICOS**

**CENTRAL SHELF (Optional)**

**ESTANTE CENTRAL (Opcional)**



**R2Q**

For medication labels dispenser,  
syringe identification

Para dispensador de etiquetas  
de medicación, identificación de  
jeringuillas

**DIVIDERS (Optional)**

**SEPARADORES (Opcional)**



**6 DMQ**



**Q096 W**  
SQ061 W.26(RA4Q.A5).30.32L

**ANAESTHESIA ANESTESIA**  
**300 SERIES SERIE** **CE**

**ISO**  
**640 x 480 mm**

**EMERGENCY ROOM, OPERATING ROOM, REANIMATION AREA**  
**SERVICIO URGENCIAS, QUIRÓFANO, URPA**



**STATIC TROLLEYS**  
**CARROS ESTÁTICOS**



**3684 B**  
 365 B.26(RA4.A5.R2).30.32L

**CENTRAL SHELF**  
**ESTANTE CENTRAL**



**R2**

For medication labels dispenser,  
 syringe identification

Para dispensador de etiquetas  
 de medicación, identificación de  
 jeringuillas

**DIVIDER SET (Optional)**  
**CONJUNTO SEPARADORES (Opcional)**



**H5/16**



**ANAESTHESIA ANESTESIA**  
**300 SERIES SERIE** 

**ISO**  
**640 x 480 mm**

**EMERGENCY ROOM, OPERATING ROOM, REANIMATION AREA**  
**SERVICIO URGENCIAS, QUIRÓFANO, URPA**



**STATIC TROLLEYS**  
**CARROS ESTÁTICOS**

**LAPTOP BASE**  
**BASE ORDENADOR PORTÁTIL**



**27EV**



**3611 G**  
365 G.26(RA4.A5).27EV.32R

**ANAESTHESIA ANESTESIA**  
**300 SERIES SERIE** 

**ISO**  
**640 x 480 mm**



**STATIC TROLLEYS**  
**CARROS ESTÁTICOS**



**3607 G**  
 365 G.26(RA4.A5).32R



**3650 G**  
 365 G.26(RA4.A5).30.(2)32L



**3680 Y**  
 365 Y.26(RA5.A5.R1).30.33L



**3609 Y**  
 365 Y.26(RA4.A5).(2)32R.33L



**3685 B**  
 365 B.26(RA4.A5.R2).30.(2)32L



**3687 B**  
 365 B.26(RA4.A5.R2).30.33L.44L



**3694 W**  
 362M6 W.26(RA4.A5.R2).30.32L



**3695 W**  
 362M6TX W.26M(R75M).30.(2)32L



**STATIC TROLLEYS**  
**CARROS ESTÁTICOS**

**ANAESTHESIA**  
**ANESTESIA**



**3607MRI G**  
365MRI G.26(RA4.A5).32R



**3 Tesla**

Certificate of MRI conformance  
Certificado de conformidad MRI

**3 GLOVE BOX HOLDER (Optional)**  
**SOPORTE 3 CAJAS DE GUANTES**  
(Opcional)



**46**

**BIN (Optional)**  
**CUBO (Opcional)**



**50 - 13 LITRES LITROS**  
**51 - 26 LITRES LITROS**

**MRI ROOM SALA DE RESONANCIA MAGNÉTICA MRI** **CE**

**ISO**  
**640 x 480 mm**



**STATIC TROLLEYS**  
**CARROS ESTÁTICOS**

Trolley manufactured with antimagnetic materials  
4 antistatic wheels with brake

Carro fabricado con materiales antimagnéticos  
4 ruedas antiestáticas con freno



**3 Tesla**

Certificate of MRI conformance  
Certificado de conformidad MRI

**MULTIFUNCTION**  
**MULTIFUNCIÓN**



**305MRI**

**MULTIFUNCTION**  
**MULTIFUNCIÓN**



**3102MRI B**  
322MRI B.32R

**MULTIFUNCTION**  
**MULTIFUNCIÓN**



**3126MRI W**  
364MRI W.32R

**MULTIFUNCTION**  
**MULTIFUNCIÓN**



**3129MRI W**  
365MRI W.32R

**EMERGENCY**  
**EMERGENCIA**



**3232MRI R**  
365MRI R.12.14.(2)32R.36.41

**STORAGE**  
**ALMACÉN**



**706MRI 0P.AST7.(2)60.(4)72.73**

**DIFFICULT INTUBATION INTUBACIÓN DIFÍCIL**  
**300 SERIES SERIE** **CE**

**ISO**  
**640 x 480 mm**



**3702 W**  
 364M6 W.12B.14.32R



**3708 W**  
 364M6 W.12B.14.26LW(R2).32R.36.44L

**SUCTION UNIT SUPPORT**  
**(Optional)**  
**SOPORTE ASPIRADOR**  
**(Opcional)**



**39R**

**ISOLATION AISLAMIENTO**  
**300 SERIES SERIE** **CE**

**ISO**  
**640 x 480 mm**

Infection control

To store protective disposable material, clothes, caps, masks, gloves, hose

Control de infecciones

Para almacenar material desechable de protección, ropa, gorros, mascarillas, guantes, calzas



**3732 Y**  
 366M6 Y.46



**3738 Y**  
 366M6 Y.46.48L.51

**GOWN SUPPORT**  
**(Optional)**  
**SOPORTE PARA BATAS**  
**(Opcional)**



**41**

**PLASTER TROLLEY CARRO DE YESOS**  
**300 SERIES SERIE C E**

**ISO**  
**900 x 630 mm**

Stainless steel AISI-304 monobloc structure.

Polyethylene work surface, PE

**LXN** Stainless steel protection, resists contact with fiberglass bandages

Estructura monobloque de acero inoxidable AISI-304

Superficie de trabajo de polietileno, PE

**LXN** Protección de acero inoxidable, resiste el contacto de vendas con fibra de vidrio



**BANDAGE SHELF ROLLS**  
**ESTANTE ROLLOS VENDAS**

5 dividers, adjustable  
 5 separadores, regulables



**R12N**

**2 PLASTER-BASIN SUPPORT**  
**SOPORTE 2 CUBETAS YESO**

Two 9 litres basins, PP  
 Removable, supports on ref. 37NR

Dos cubetas de 9 litros, PP  
 Desmontable, apoya en ref. 37NR



**49RI**

**3890 W**  
 N322 W.LXN.26(R12N.R2N).37NR.49RI

**EMERGENCY EMERGENCIA**



**EMERGENCY EMERGENCIA**





**EMERGENCY EMERGENCIA**  
**SQM CE**

~~ISO~~

**480 x 480 mm**



**EXTENSIVE MOBILITY TROLLEYS**

**CARROS ALTA MOVILIDAD**

Defibrillator Desfibrilador **Bexen cardio**



**Q260 R**  
SQ161 R.12.14.28.32R.34.36.40

**DIVIDERS (Optional)**  
**SEPARADORES (Opcional)**



**6 DMQ**

**SUCTION UNIT SUPPORT (Optional)**  
**SOPORTE ASPIRADOR (Opcional)**



**39R**

**EMERGENCY EMERGENCIA**  
**SQM CE**

~~ISO~~  
**480 x 480 mm**



**EXTENSIVE MOBILITY TROLLEYS**

**CARROS ALTA MOVILIDAD**

Security, manual locking  
 Numbered disposable seals  
 The seal guarantees that the trolley has been prepared and checked

Seguridad, bloqueo manual  
 Precintos desechables numerados  
 El precinto garantiza que el carro ha sido preparado y revisado



**Q200 R**  
 SQ021 R.AST.12B.14  
 Wheels Ruedas Ø 100 mm



**Q222 R**  
 SQ161 R.12.14.36.40



**Q272 B**  
 SQ161 B.12.14.34.36.40



**Q250 R**  
 SQ161 R.12.14.30.34.36.40



**Q299 R**  
 SQ161 R.12.14.28.32R.34.36.39R.40



**Q265 R**  
 SQ161 R.12.14.26(R7Q).32R.34.36.40



**Q224 R**  
 SQ161 R.12.14.26LW(R7Q).28EV.  
 32R.34.36.40

**BROSELOW PAEDIATRIC EMERGENCY  
EMERGENCIA PEDIÁTRICA BROSELOW  
100 SERIES SERIE **

**ISO**

**640 x 480 mm**

**BROSELOW PAEDIATRIC TAPE  
(Optional)  
CINTA PEDIÁTRICA BROSELOW  
(Opcional)**



**TBR**



600 x 400 mm ISO drawers  
**HBR** Broselow 9 colour card holder set  
Upper drawer without divider  
4 drawers divided into 2 equal parts  
Auxiliary lower drawer without divider  
Cajones ISO 600 x 400 mm  
**HBR** Conjunto portatarjetas 9 colores Broselow  
Cajón superior sin divisor  
4 cajones divididos en 2 partes iguales  
Cajón inferior auxiliar sin divisor



**1200 W**  
164M6 W.HBR.12B.14.36.40.(4)DS10



**1203 W**  
164M6 W.HBR.12B.14.28.34.36.40.(4)DS10

**EMERGENCY EMERGENCIA**  
**100 SERIES SERIE** 

**ISO**  
**640 x 480 mm**



**EXTENSIVE MOBILITY TROLLEYS**

**CARROS ALTA MOVILIDAD**

Security, manual locking  
 Numbered disposable seals  
 The seal guarantees that the trolley has been prepared and checked

Seguridad, bloqueo manual  
 Precintos desechables numerados  
 El precinto garantiza que el carro ha sido preparado y revisado

**2 DUAL LOCK WHEELS (Optional)**

**2 RUEDAS DOBLE BLOQUEO (Opcional)**

Ø 125 mm



Fixed wheel

Rueda fija



Swivel wheel

Rueda giratoria



Locked wheel

Rueda bloqueada



**1296 R**  
 165 R.12.14.28.32R.34.36.40

**DIVIDER SET (Optional)**

**CONJUNTO SEPARADORES (Opcional)**



**H5/16**

**SUCTION UNIT SUPPORT (Optional)**

**SOPORTE ASPIRADOR (Opcional)**



**39R**

**EMERGENCY EMERGENCIA**  
**100 SERIES SERIE** 

**ISO**

**640 x 480 mm**



**EXTENSIVE MOBILITY TROLLEYS**

**CARROS ALTA MOVILIDAD**

**DIVIDER SET (Optional)**

**CONJUNTO SEPARADORES (Opcional)**



**H5/16**



**ROTATING ARM FOR DEFIBRILLATOR**

**BRAZO GIRATORIO PARA DESFIBRILADOR**



**28EV**

**13 LITRES BIN (Optional)**

**CUBO 13 LITROS (Opcional)**



**50**



**1210 R**

162M6 R.12.14.26(RA5.A5.R1).28EV.32R.34.36.40

**EMERGENCY EMERGENCIA**  
**100 SERIES SERIE** 

**ISO**  
**640 x 480 mm**



**EXTENSIVE MOBILITY TROLLEYS**

**CARROS ALTA MOVILIDAD**



**1270 R**  
 165 R.12.14.28.36.40



**1272 B**  
 165 B.12.14.34.36.40



**1208 R**  
 162M6 R.12.14.28.32R.34.36.40



**1254 R**  
 165 R.12.14.32R.34.36.40.46



**1266 R**  
 165 R.12.14.28.34.36.40.44L



**1280 R**  
 165 R.12.14.30.34.36.40



**1299 R**  
 165 R.12.14.28.32R.34.36.39R.40



**1282 R**  
 165 R.12.14.26LW(R1).30.34.36.40



**1224 R**  
 165 R.12.14.26LW(R7).28EV.  
 32R.34.36.40

# TREATMENT CURAS



## TREATMENT CURAS





**TREATMENT CURAS**  
**SQM CE**

**HOSPITALIZATION UNITS**  
**UNIDADES DE HOSPITALIZACIÓN**

**COMPUTER MEDICAL TROLLEY**  
**CARRO MÉDICO PARA ORDENADOR**

~~ISO~~  
**480 x 480 mm**



**EXTENSIVE MOBILITY TROLLEYS**  
**CARROS ALTA MOVILIDAD**

**VESA MONITOR SUPPORT**  
**SOPORTE PARA MONITOR VESA**



**26M(R75QM)**  
3 Positions, adjustable  
3 Posiciones, regulable

**CABLE LEAD THROUGH**  
**PASACABLES**



**KEYBOARD DRAWER**  
**CAJÓN PARA TECLADO**



**Q190 W**  
SQ161TXQ W.26M(R75QM).30.32L.46.50

**TREATMENT CURAS**  
**SQM CE**

~~ISO~~

**480 x 480 mm**

**HOSPITALIZATION UNITS**

**UNIDADES DE HOSPITALIZACIÓN**



**EXTENSIVE MOBILITY TROLLEYS**

**CARROS ALTA MOVILIDAD**



**Q605 W**  
SQ022 W.AST.32R.50  
Wheels Ruedas Ø 100 mm



**Q105 B**  
SQ132 B.32R.50



**Q108 W.(6)CO**  
SQ161 W.27.32R.46.50.(6)CO



**Q106 W**  
SQ161 W.32R.46.50



**Q112 W**  
SQ161 W.32R.46.48L.50



**Q136 B**  
SQ161 B.26LW(R1Q).33R.46.50



**Q142 B**  
SQ161 B.30.32L.46.50



**Q150 B**  
SQ161 B.26LW(R1Q).30.46.50



**Q158 W**  
SQ161 W.26(RA5Q.A5.R1Q).  
30.33L.46.50

**TREATMENT CURAS**  
**100 SERIES SERIE** 

**ISO**

**640 x 480 mm**

**HOSPITALIZATION UNITS**

**UNIDADES DE HOSPITALIZACIÓN**



**EXTENSIVE MOBILITY TROLLEYS**

**CARROS ALTA MOVILIDAD**

**COMPUTER MEDICAL TROLLEY**

**CARRO MÉDICO PARA ORDENADOR**

**VESA MONITOR SUPPORT**

**SOPORTE PARA MONITOR VESA**



**26M(R75M)**

3 Positions, adjustable

3 Posiciones, regulable

**CABLE LEAD THROUGH**

**PASACABLES**



**KEYBOARD DRAWER**

**CAJÓN PARA TECLADO**



**1690 B**

162M6TX B.26M(R75M).32R.46.50

**TREATMENT CURAS**  
**100 SERIES SERIE** 

**ISO**  
**640 x 480 mm**

**HOSPITALIZATION UNITS**  
**UNIDADES DE HOSPITALIZACIÓN**



**EXTENSIVE MOBILITY TROLLEYS**  
**CARROS ALTA MOVILIDAD**

**LAPTOP BASE**  
**BASE ORDENADOR PORTÁTIL**



**27EV**



**1654 F**  
165 F.26LW(R1).27EV.30.46.51



**CENTRAL SUPPORT**  
**SOPORTE CENTRAL**



**R1**



Contaminated waste on  
right side

Desechos contaminados  
en lado derecho

**1638 W**  
165 W.26(RA4.A5.R1).33R.46.50

**TREATMENT CURAS**  
**100 SERIES SERIE** 

**HOSPITALIZATION UNITS**

**UNIDADES DE HOSPITALIZACIÓN**

**ISO**

**640 x 480 mm**



**EXTENSIVE MOBILITY TROLLEYS**

**CARROS ALTA MOVILIDAD**



**1602 G**  
133 G.32R.50



**1606 B**  
165 B.32R.46.50



**1650 W**  
165 W.26LW(R1).30.46.50



**1608 W**  
165 W.27.32R.46.50



**1625 B**  
165 B.32L.33R.46.50



**1636 G**  
165 G.26LW(R1).33R.46.50



**1642 B**  
165 B.30.32L.46.50

**MANAGEMENT MEDICATION WITH INTERCHANGEABLE CASSETTES**  
**GESTIÓN DE LA MEDICACIÓN CON CASETES INTERCAMBIABLES**



**MANAGEMENT MEDICATION WITH INTERCHANGEABLE CASSETTES**  
**GESTIÓN DE LA MEDICACIÓN CON CASETES INTERCAMBIABLES**

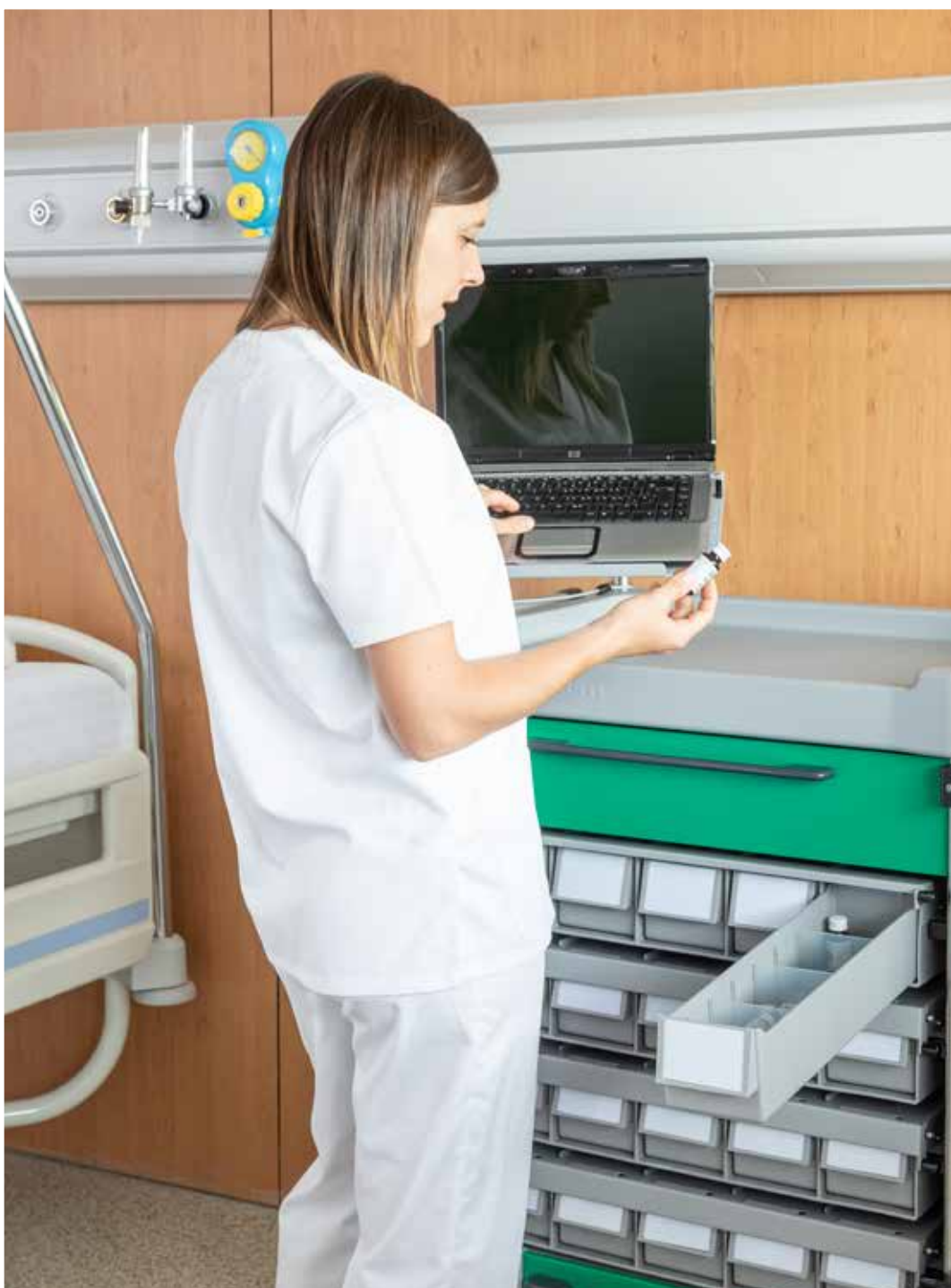



**TRANSPORT TROLLEYS WITH CASSETTES CARROS DE TRANSPORTE CON CASETES**



**TRANSPORT TROLLEYS WITH CASSETTES CARROS DE TRANSPORTE CON CASETES**



**TRANSPORT TROLLEYS WITH CASSETTES**  
**CARROS DE TRANSPORTE CON CASETES**

**600 SERIES SERIE**

**HOSPITAL PHARMACY**

**FARMACIA HOSPITALARIA**

Key locking  
 C5, unit dose medication cassettes  
 600 x 400 mm ISO drawers  
 Maximum capacity 10 cassettes

Bloqueo de llave  
 C5, casetes medicación unidosis  
 Cajones ISO 600 x 400 mm  
 Capacidad máxima 10 casetes



**606 OP.10M10.TP.(8)C5.(2)72**

**ISO**  
**640 x 480 mm**

**UPPER SUPPLEMENT (optional)**  
**SUPLEMENTO SUPERIOR (opcional)**



**68**

**LOCK STOP SET**  
**CONJUNTO DE TOPES DE BLOQUEO**





Lock the guides of the ISO panel that are not used  
 Bloquean las guías del panel ISO que no se usan

**TP**

**2 DUAL LOCK WHEELS Ø 125 mm**  
**2 RUEDAS DOBLE BLOQUEO Ø 125 mm**



-  Fixed wheel  
Rueda fija
-  Swivel wheel  
Rueda giratoria
-  Locked wheel  
Rueda bloqueada

**TRANSPORT TROLLEYS WITH CASSETTES**  
**CARROS DE TRANSPORTE CON CASETES**

**ISO**

**960 x 640 mm**

**600 SERIES SERIE**

**HOSPITAL PHARMACY**

**FARMACIA HOSPITALARIA**

Key locking, on both sides  
 C5, unit dose medication cassettes  
 600 x 400 mm ISO drawers  
 Maximum capacity 9 + 9 = 18 cassettes

Bloqueo de llave, ambos lados  
 C5, casetes medicación unidosis  
 Cajones ISO 600 x 400 mm  
 Capacidad máxima 9 + 9 = 18 casetes



**618 OP.(2)10M9.(2)TP.(16)C5.(2)72**

**UPPER SUPPLEMENT (optional)**  
**SUPLEMENTO SUPERIOR (opcional)**



**68B**

**LOCK STOP SET**  
**CONJUNTO DE TOPES DE BLOQUEO**





Lock the guides of the ISO panel that are not used  
 Bloquean las guías del panel ISO que no se usan

**TP**

**2 DUAL LOCK WHEELS Ø 125 mm**  
**2 RUEDAS DOBLE BLOQUEO Ø 125 mm**



-  Fixed wheel  
Rueda fija
-  Swivel wheel  
Rueda giratoria
-  Locked wheel  
Rueda bloqueada

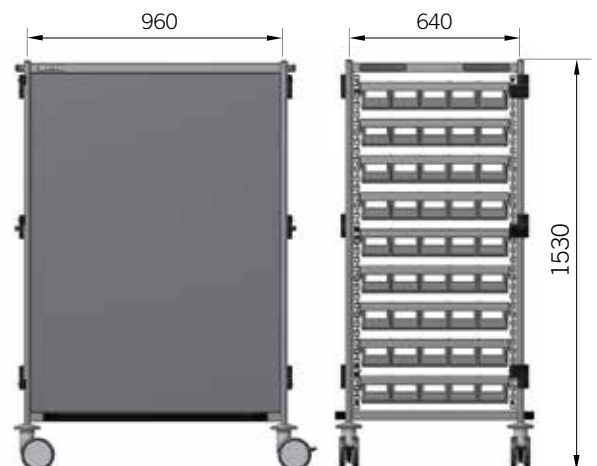

**UNIT DOSE MEDICATION    MEDICACIÓN UNIDOSIS**



# UNIT DOSE MEDICATION MEDICACIÓN UNIDOSIS



**UNIT DOSE MEDICATION MEDICACIÓN UNIDOSIS**  
**600 / 100 SERIES SERIE C€**

**ISO**

**INTERCHANGEABLE CASSETTE, 5 PATIENTS CASETE INTERCAMBIABLE, 5 PACIENTES**

Compatible with pharmacy ISO furniture  
 Polypropylene and epoxy painted steel, grey colour  
 Cassette locked **PATENTED**  
 Locked cassette, upper part of the label hidden, lower part visible

Compatible con el mobiliario ISO de la farmacia  
 Polipropileno y acero pintado epoxi, color gris  
 Bloqueo casete **PATENTADO**  
 Casete bloqueado, parte superior de la tarjeta oculta, parte inferior visible



**C5**

**MEDICATION CONTAINER CONTENEDOR DE MEDICACIÓN**

Capacity: 3 litres  
 ISO norm 7810 identification card, international standard  
 Appropriate for intravenous therapy medication, re-packaged medication in unit doses, pills, prefilled syringes, syrups, etc

Capacidad: 3 litros  
 Tarjeta de identificación norma ISO 7810, estándar internacional  
 Adecuado para medicación de terapia intravenosa, medicación reenvasada en dosis unitarias, comprimidos, jeringas precargadas, jarabes, etc

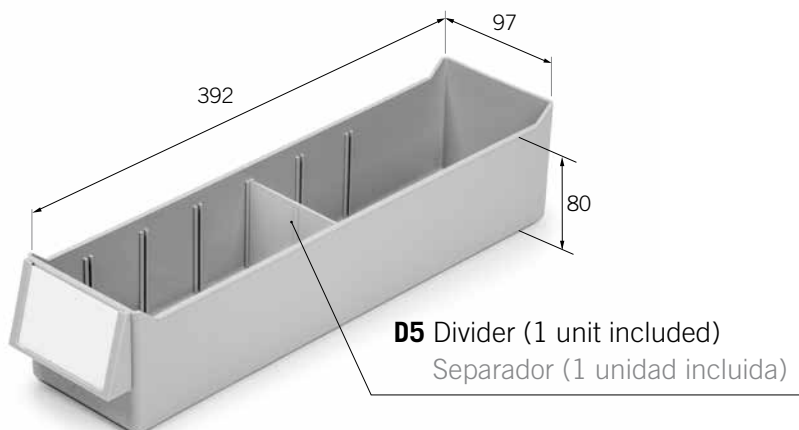

**UNIT DOSE MEDICATION MEDICACIÓN UNIDOSIS**  
**100 SERIES SERIE** 

**ISO**  
**640 x 480 mm**

Key locking (included)

Bloqueo de llave (incluido)



**106M6**

**106M6TX**

Keyboard drawer, cable lead through

Cajón para teclado, pasacables



**108M6**



**110M6**

**110M6TX**

Keyboard drawer, cable lead through

Cajón para teclado, pasacables



**112M6**



**113M6**

**113M6TX**

Keyboard drawer, cable lead through

Cajón para teclado, pasacables



**114M6**



**115M6**



**116M6**



**119M6**

1005  
 1043



**UNIT DOSE MEDICATION MEDICACIÓN UNIDOSIS**  
**100 SERIES SERIE 100** **CE**

**ISO**  
**640 x 480 mm**

**HOSPITALIZATION UNITS**

**UNIDADES DE HOSPITALIZACIÓN**

Key locking (included)  
Interchangeables cassettes, 5 patients

Bloqueo de llave (incluido)  
Casetes intercambiables, 5 pacientes

Syringes drawer  
Cajón jeringas



**MEDICATION CONTAINER**  
**CONTENEDOR DE MEDICACIÓN**

3 Litres Litros

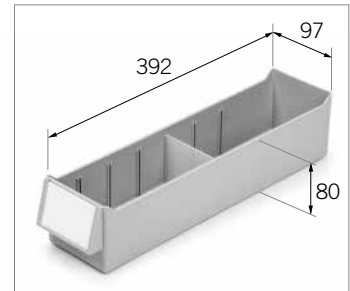

**ELEVATED HANGER SUPPORT**  
**(Optional)**  
**SOPORTE COLGADOR ELEVADO**  
**(Opcional)**

For serum preparation  
Para preparación de sueros



**41**

Serum drawer  
Cajón sueros

**1809 W**  
112M6 W.32R.46.50

**UNIT DOSE MEDICATION MEDICACIÓN UNIDOSIS**  
**100 SERIES SERIE** 

**ISO**  
**640 x 480 mm**

**HOSPITALIZATION UNITS**

**UNIDADES DE HOSPITALIZACIÓN**

Syringes Jeringas

**MEDICATION CONTAINER**  
**CONTENEDOR DE MEDICACIÓN**  
3 Litres Litros

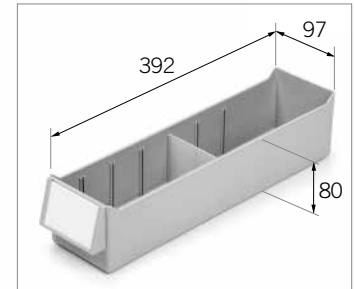

**1837 G**  
116M6 G.26(RA4.A5).27EV.32R.46.50

**UNIT DOSE MEDICATION MEDICACIÓN UNIDOSIS**  
**100 SERIES SERIE CE**

**ISO**  
**640 x 480 mm**

**HOSPITALIZATION UNITS**

**UNIDADES DE HOSPITALIZACIÓN**

**COMPUTER MEDICAL TROLLEY**

**CARRO MÉDICO PARA ORDENADOR**



**1888 B**  
113M6TX B.26M(R75M).32R.46.50

**VESA MONITOR SUPPORT**  
**SOPORTE PARA MONITOR VESA**



**26M(R75M)**

3 Positions, adjustable  
3 Posiciones, regulable

**CABLE LEAD THROUGH**  
**PASACABLES**



**KEYBOARD DRAWER**  
**CAJÓN PARA TECLADO**



**UNIT DOSE MEDICATION MEDICACIÓN UNIDOSIS**  
**100 SERIES SERIE** 

**ISO**  
**640 x 480 mm**



**1808 W**  
 108M6 W.32R.46.50



**1813 Y**  
 112M6 Y.27.32R.46.50



**1822 F**  
 112M6 F.26LW(R1).30.46.50



**1828 W**  
 110M6TX W.26M(R75M).32R.46.50



**1838 G**  
 116M6 G.26(RA4.A5.R1).32R.46.50



**1894 B**  
 114M6 B.32R.46.50



**1895 B**  
 114M6 B.26(RA4.A5).32R.46.50



**1896 B**  
 114M6 B.26(RA4.A5).27EV.32R.46.50



**1898 Y**  
 119M6 Y.32R.46.50

**TRANSPORT TROLLEYS CARROS DE TRANSPORTE**  
**500 SERIES SERIE**

**900 x 570 mm**

Structure of AISI-304 stainless steel  
Union with TIG welding  
Load capacity 150 kg  
Ø 125 mm wheels  
2 antistatic, 2 with brake at left side  
High-tech wheels

Estructura de acero inoxidable AISI-304  
Unión con soldadura TIG  
Capacidad de carga 150 kg  
Ruedas Ø 125 mm  
2 antiestáticas, 2 con freno lado izquierdo  
Ruedas de alta tecnología



**530**



**520**

**INSTRUMENT TRANSPORT TROLLEYS**  
**CARROS DE TRANSPORTE PARA INSTRUMENTAL**  
**500 SERIES SERIE**



**900 x 630 mm**

For 600 x 300 mm containers  
 Monobloc structure of AISI-304 stainless steel  
 Union with rivets and TIG welding  
 Load capacity 150 kg  
 Key locking  
 Non-airtight phenolic doors

Para contenedores de 600 x 300 mm  
 Estructura monobloque de acero inoxidable AISI-304  
 Unión con remaches y soldadura TIG  
 Capacidad de carga 150 kg  
 Bloqueo de llave  
 Puertas fenólico de cierre no hermético

**2 DUAL LOCK WHEELS** Ø 125 mm  
**2 RUEDAS DOBLE BLOQUEO** Ø 125 mm



-  Fixed wheel  
Rueda fija
-  Swivel wheel  
Rueda giratoria
-  Locked wheel  
Rueda bloqueada



**567 DN**

**566 DN** Trolley with 2 smooth central shelves  
 Carro con 2 estantes centrales lisos

**567 DN** Trolley with 2 perforated central shelves for ventilation  
 Carro con 2 estantes centrales perforados para ventilación

**TRANSPORT TROLLEYS CARROS DE TRANSPORTE**  
**600 SERIES SERIE**

**ISO**  
**640 x 480 mm**

Monobloc structure of AISI-304 stainless steel  
 Union with rivets and TIG welding  
 Phenolic doors with key locking  
 600 x 400 mm ISO drawers  
 Maximum capacity 10 ISO drawers 100 mm height

Estructura monobloque de acero inoxidable AISI-304  
 Unión con remaches y soldadura TIG  
 Puertas de fenólico con bloqueo de llave  
 Cajones ISO 600 x 400 mm  
 Capacidad máxima 10 cajones ISO altura 100 mm



**606 DN.(6)72.(2)73**

**UPPER SUPPLEMENT (optional)**  
**SUPLEMENTO SUPERIOR (opcional)**



**68**

**ADJUSTABLE SHELF (optional)**  
**BANDEJA REGULABLE (opcional)**



**60 - 600 x 440 mm**

**RETENTION STOP (Optional)**  
**TOPE DE RETENCIÓN (Opcional)**



1 set per drawer 1 juego por cajón



**TR**

**2 DUAL LOCK WHEELS Ø 125 mm**  
**2 RUEDAS DOBLE BLOQUEO Ø 125 mm**



-  Fixed wheel  
Rueda fija
-  Swivel wheel  
Rueda giratoria
-  Locked wheel  
Rueda bloqueada

**TRANSPORT TROLLEYS CARROS DE TRANSPORTE**  
**600 SERIES SERIE**

**ISO**  
**900 x 630 mm**

Monobloc structure of AISI-304 stainless steel  
 Union with rivets and TIG welding  
 Phenolic doors with key locking  
 400 x 600 mm ISO drawers  
 Maximum capacity 10 + 10 = 20 ISO drawers 100 mm height

Estructura monobloque de acero inoxidable AISI-304  
 Unión con remaches y soldadura TIG  
 Puertas de fenólico con bloqueo de llave  
 Cajones ISO 400 x 600 mm  
 Capacidad máxima 10 + 10 = 20 cajones ISO altura 100 mm

**UPPER SUPPLEMENT (optional)**  
**SUPLEMENTO SUPERIOR (opcional)**



**68B**

**ADJUSTABLE SHELF (optional)**  
**BANDEJA REGULABLE (opcional)**



**62 - 400 x 610 mm**

**RETENTION STOP (Optional)**  
**TOPE DE RETENCIÓN (Opcional)**



1 set per drawer 1 juego por cajón



**TR**

**2 DUAL LOCK WHEELS Ø 125 mm**  
**2 RUEDAS DOBLE BLOQUEO Ø 125 mm**



-  Fixed wheel  
Rueda fija
-  Swivel wheel  
Rueda giratoria
-  Locked wheel  
Rueda bloqueada



**620 DN.(12)72.(4)73**



**TRANSPORT TROLLEYS CARROS DE TRANSPORTE**  
**600 SERIES SERIE**

**ISO**  
**640 x 480 mm**

Adjustable shelf, phenolic  
 600 x 400 mm ISO drawers

Bandeja regulable, fenólico  
 Cajones ISO 600 x 400 mm

**COMBINED TROLLEY**  
**CARRO COMBINADO**

Shelves for bulky material  
 Drawers with slides for heavy material

Bandejas para material voluminoso  
 Cajones con correderas para material pesado



**632 DN.(2)60**

**UPPER SUPPLEMENT (optional)**  
**SUPLEMENTO SUPERIOR (opcional)**



**68**

**RETENTION STOP (Optional)**  
**TOPE DE RETENCIÓN (Opcional)**



1 set per drawer 1 juego por cajón



**TR**

**2 DUAL LOCK WHEELS Ø 125 mm**  
**2 RUEDAS DOBLE BLOQUEO Ø 125 mm**



-  Fixed wheel  
Rueda fija
-  Swivel wheel  
Rueda giratoria
-  Locked wheel  
Rueda bloqueada

**TRANSPORT TROLLEYS CARROS DE TRANSPORTE**  
**600 SERIES SERIE**

**ISO**  
**640 x 480 mm**



**606 OP.(8)72.73**



**606 DN.(3)60**



**606 DN.(3)60.(2)72.73**



**606 DN.(2)60.(4)72.73**



**606 DN.(8)72.73**



**631 DN.(2)60**



**651 DN**



**652 DN**



**657 DN**

1645

**STORAGE FURNITURE MOBILIARIO DE ALMACÉN**  
**700 SERIES SERIE**

**ISO**

**640 x 480 mm**

Adjustable shelf, phenolic  
600 x 400 mm ISO drawers

Bandeja regulable, fenólico  
Cajones ISO 600 x 400 mm

**COMBINED TROLLEY**  
**CARRO COMBINADO**

Shelves for bulky material  
Drawers with slides for heavy material

Bandejas para material voluminoso  
Cajones con correderas para material pesado



**771 F.60**

**CATHETERS SHELF**  
**BANDEJA PARA CATÉTERES**



**60CAT**

**CATHETERS ISO TROLLEY**  
**CARRO ISO PARA CATÉTERES**



**706 DN.60CAT**

**STORAGE FURNITURE MOBILIARIO DE ALMACÉN**  
**700 SERIES SERIE**

**ISO**  
**640 x 480 mm**

**RETENTION STOP (Optional)**  
**TOPE DE RETENCIÓN (Opcional)**  
 1 set per drawer 1 juego por cajón



**TR**



**706 OP.(8)72.73**



**706 DN.(3)60**



**706 DN.(3)60.(2)72.73**



**706 DN.(2)60.(4)72.73**



**706 DN.(6)72.(2)73**



**772 G.60**



**752 W**



**752 W.10M11**



**SQUARE TROLLEYS CARROS CUADRADOS**

**SQS CE**

~~ISO~~

**480 x 480 mm**



**STATIC TROLLEYS  
CARROS ESTÁTICOS**



**SQ010**



**SQ005**



**SQ040**



**SQ021**

**SQ021TXQ**

Keyboard drawer, cable  
lead through

Cajón para teclado, pasacables



**SQ022**



**SQ032**



**SQ033**



**SQ061**

**SQ061TXQ**

Keyboard drawer, cable  
lead through

Cajón para teclado, pasacables



**SQ065**

**SIMPLE TROLLEYS CARROS SIMPLES**  
**300 SERIES SERIE** **CE**

**ISO**  
**640 x 480 mm**

 **STATIC TROLLEYS**  
**CARROS ESTÁTICOS**



**310**



**305**



**321**  
**321TX**

Keyboard drawer, cable lead through  
 Cajón para teclado, pasacables



**322**



**332**  
**332TX**

Keyboard drawer, cable lead through  
 Cajón para teclado, pasacables



**333**



**334**



**341**



**346**

**SIMPLE TROLLEYS CARROS SIMPLES**  
**300 SERIES SERIE** 

**ISO**  
**640 x 480 mm**



**STATIC TROLLEYS**  
**CARROS ESTÁTICOS**

**M6** Structure for 6 100 mm ISO drawers

**M6** Estructura para 6 cajones ISO 100 mm



**364**



**365**



**366**



**361M6**



**362M6**

**362M6TX**

Keyboard drawer, cable lead through

Cajón para teclado, pasacables



**364M6**



**365M6**



**366M6**



**367M6**



**DOUBLE TROLLEYS CARROS DOBLES**  
**300 SERIES SERIE** 

**ISO**  
**900 x 630 mm**



**STATIC TROLLEYS**  
**CARROS ESTÁTICOS**



**N310**



**N305**



**N321**



**N322**



**N364**



**N365**



**N366**

**DOUBLE TROLLEYS CARROS DOBLES**  
**300 SERIES SERIE** 

**ISO**  
**900 x 630 mm**



**STATIC TROLLEYS**  
**CARROS ESTÁTICOS**

**M12** Structure for 12 100 mm ISO drawers

**M12** Estructura para 12 cajones ISO 100 mm



**N361M12**



**N362M12**



**N364M12**



**N365M12**



**N366M12**



**N367M12**

**LOW TROLLEYS, REDUCED HEIGHT CARROS BAJOS, ALTURA REDUCIDA** 

**LOW SQUARE TROLLEYS CARROS CUADRADO BAJOS**

 **STATIC TROLLEYS**  
CARROS ESTÁTICOS

~~ISO~~  
**480 x 480 mm**



**SQ061M4LW**



**SQ064M4LW**

**LOW SIMPLE TROLLEYS CARROS SIMPLES BAJOS**

 **STATIC TROLLEYS**  
CARROS ESTÁTICOS

**ISO**  
**640 x 480 mm**



**361M5LW**



**362M5LW**



**364M5LW**



**365M5LW**



**366M5LW**

To store it under 900 mm work tables  
 For users working in sitting position

Para guardarlos debajo de mesas de trabajo de 900 mm  
 Para el usuario que trabaja en posición sentada

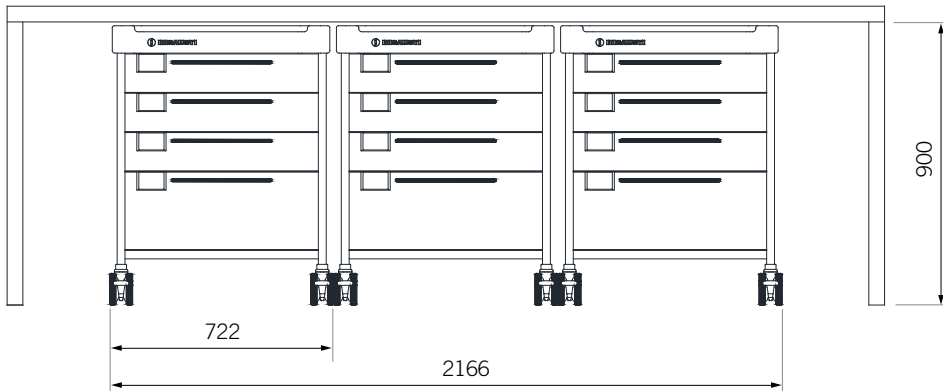

**LOW DOUBLE TROLLEYS CARROS DOBLES BAJOS**

**ISO  
 900 x 630 mm**

 **STATIC TROLLEYS**  
**CARROS ESTÁTICOS**



**N361M10LW**



**N362M10LW**



**N364M10LW**



**N365M10LW**



**N366M10LW**

**SQUARE TROLLEYS CARROS CUADRADOS**

**SQM** 

~~ISO~~  
**480 x 480 mm**



**EXTENSIVE MOBILITY TROLLEYS**

**CARROS ALTA MOVILIDAD**



**SQ132**



**SQ133**



**SQ161**

**SQ161TXQ**

Keyboard drawer, cable  
lead through

Cajón para teclado, pasacables



**SQ165**

**SIMPLE TROLLEYS CARROS SIMPLES**  
**100 SERIES SERIE** 

**ISO**  
**640 x 480 mm**



**EXTENSIVE MOBILITY TROLLEYS**  
**CARROS ALTA MOVILIDAD**

**M6** Structure for 6 100 mm ISO drawers

**M6** Estructura para 6 cajones ISO 100 mm



**132**



**133**



**164**



**165**



**166**



**162M6**

**162M6TX**

Keyboard drawer, cable lead through

Cajón para teclado, pasacables



**164M6**



**165M6**



**166M6**

**ACCESSORIES ACCESORIOS**

**SQUARE TROLLEY DIVIDERS SEPARADORES CARRO CUADRADO**

PC, polycarbonate PC, policarbonato

**DMQ - Height Altura 57 mm**



**DSQ - Height Altura 130 mm**

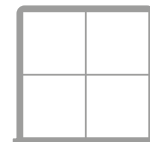
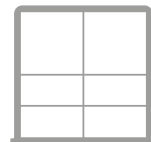
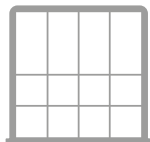
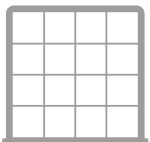

## ACCESSORIES ACCESORIOS

### ISO DRAWER DIVIDER SET CONJUNTO SEPARADORES CAJONES ISO

Dividers for 600 x 400 mm ISO drawers  
PC, polycarbonate

Separadores para cajones ISO 600 x 400 mm  
PC, policarbonato

Drawer Cajón 50 mm  
**DL5, DS5**

Drawer Cajón 100 mm  
**DL10, DS10**

Drawer Cajón 200 mm  
**DL20, DS20**

**DS5** 400 mm  
**DL5** 600 mm

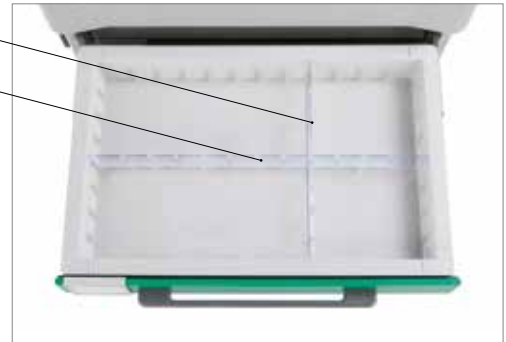

**H5/16**  
ISO drawer Cajón ISO 50 mm



**H10/9**  
ISO drawer Cajón ISO 100 mm

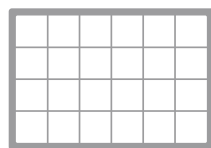

**H5/24**

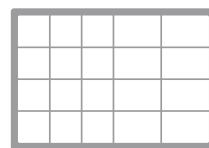

**H5/20**

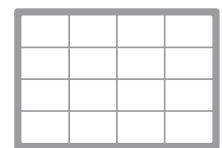

**H5/16**

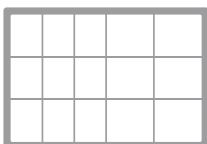

**H5/15**

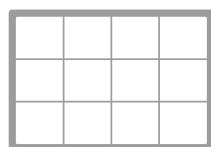

**H5/12, H10/12**

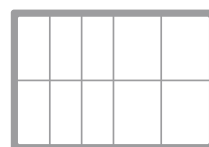

**H5/10, H10/10**

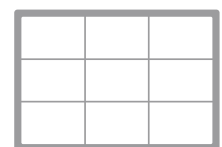

**H5/9, H10/9, H20/9**

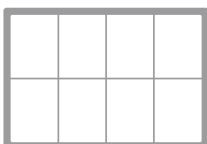

**H5/8, H10/8, H20/8**

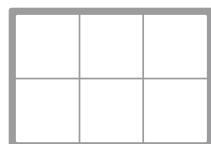

**H5/6, H10/6, H20/6**

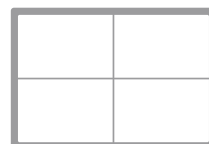

**H10/4, H20/4**

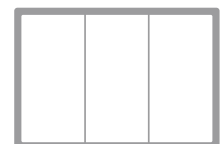

**H10/3, H20/3**



## ACCESSORIES ACCESORIOS

### KEY LOCKING BLOQUEO DE LLAVE



#### **10**

Square, simple trolley, total locking  
Carro cuadrado, simple, bloqueo total

#### **10N2**

Double trolley, total locking  
Left side, right side  
Carro doble, bloqueo total  
Lado izquierdo, lado derecho

#### **10M2**

Square trolley, 2 130 mm drawers locking  
Simple trolley, 2 100 mm ISO drawers locking  
Carro cuadrado, bloqueo 2 cajones 130 mm  
Carro simple, bloqueo 2 cajones ISO 100 mm



#### **10D**

Square trolley, 2 57 mm drawers locking  
Simple trolley, 2 50/100 mm ISO drawers locking  
Carro cuadrado, bloqueo 2 cajones 57 mm  
Carro simple, bloqueo 2 cajones ISO 50/100 mm

#### **10DN2**

Double trolley, 4 ISO drawers locking  
50/100 mm left side, 50/100 mm right side  
Carro doble, bloqueo 4 cajones ISO  
Lado izquierdo 50/100 mm, lado derecho 50/100 mm

#### **10JK**

Set of 4 keys  
Juego de 4 llaves

All the locks include 4 keys Todos los bloqueos incluyen 4 llaves

### CODE LOCKING BLOQUEO DE CÓDIGO



#### **10COD**

Square, simple trolley, total locking  
Carro cuadrado, simple, bloqueo total

#### **10CODN2**

Double trolley, total locking  
Left side, right side  
Carro doble, bloqueo total  
Lado izquierdo, lado derecho

## ACCESSORIES ACCESORIOS

### SEAL LOCKING BLOQUEO PARA PRECINTOS



**12**  
 Square, simple trolley, total locking  
 Carro cuadrado, simple, bloqueo total

**12N2**  
 Double trolley, total locking  
 Left side, right side  
 Carro doble, bloqueo total  
 Lado izquierdo, lado derecho



**12D**  
 Square trolley, 2 57 mm drawers locking  
 Simple trolley, 2 50/100 mm ISO drawers locking  
 Carro cuadrado, bloqueo 2 cajones 57 mm  
 Carro simple, bloqueo 2 cajones ISO 50/100 mm

**12DN2**  
 Double trolley, 4 ISO drawers locking  
 50/100 mm left side, 50/100 mm right side  
 Carro doble, bloqueo 4 cajones ISO  
 Lado izquierdo 50/100 mm, lado derecho 50/100 mm

### INDIVIDUAL SEAL LOCKING BLOQUEO INDIVIDUAL PARA PRECINTOS

**12B**  
 Square, simple trolley, maximum 11 seals  
 Carro cuadrado, simple, máximo 11 precintos

**12BN2**  
 Double trolley, maximum 22 seals  
 11 left side, 11 right side  
 Carro doble, máximo 22 precintos  
 11 lado izquierdo, 11 lado derecho



### NUMBERED DISPOSABLE SEALS PRECINTOS DESECHABLES NUMERADOS

Number for the control of hospital emergencies  
 100 units  
 Numeración para el control de emergencias hospitalarias  
 100 unidades



**14**

## LEFT SIDE ACCESSORIES ACCESORIOS LADO IZQUIERDO

### **GAS BOTTLE STAND SOPORTE PARA BOTELLAS DE GAS**

Ø 110 mm / Ø 140 mm

Max. 18 kg

Supported with ref. 44L, 46

Compatible con ref. 44L, 46



**36**

### **3 GLOVE BOX HOLDER SOPORTE 3 CAJAS DE GUANTES**

Depth Profundidad 87 mm

Adjustable width Anchura regulable 200 - 260 mm



**46**

**460P** Open trolley Carro abierto

### **DOCUMENT HOLDER PORTADOCUMENTOS**

Height Altura 350 mm

Dimensions Dimensiones 420 x 135 mm



**59**

**RIGHT SIDE ACCESSORIES ACCESORIOS LADO DERECHO**

**FOLD DOWN TRAY BANDEJA ABATIBLE**

Polyethylene Polietileno  
Protection on all 4 sides Protección 4 lados



**30**

**SUCTION UNIT SUPPORT SOPORTE ASPIRADOR**

Useful dimensions Dimensiones útiles 250 x 420 mm  
Max. 12 kg  
Epoxy painted steel Acero pintado epoxi



**39R**

**13 LITRES BIN CUBO 13 LITROS**



**50**

**TWO 13 LITRES BINS DOS CUBOS 13 LITROS**



**50B**

**26 LITRES BIN CUBO 26 LITROS**



**51**

**25 LITRES PEDAL BIN CUBO DE PEDAL 25 LITROS**



**57**

**LEFT - RIGHT SIDE ACCESSORIES ACCESORIOS LADO IZQUIERDO - DERECHO**

**SIDE SUPPORT SOPORTE LATERAL**

Width Anchura 155 mm



**Square, simple trolley Carro cuadrado, simple**

- 32L** Left Izquierdo
- 32R** Right Derecho

**Double trolley Carro doble**

- 32NL** Left Izquierdo
- 32NR** Right Derecho

**FIXING RAIL RIEL DE FIJACIÓN**

25 x 10 mm Max. 20 kg  
Stainless steel Acero inoxidable



**Square, simple trolley Carro cuadrado, simple**

- 37L** Left Izquierdo
- 37R** Right Derecho

**Double trolley Carro doble**

- 37NL** Left Izquierdo
- 37NR** Right Derecho

**CATHETER CONTAINER  
CONTENEDOR DE CATÉTERES**

Height Altura 420 mm  
Not supported with No compatible con ref. 30, 46



- 44L** Left Izquierdo
- 44R** Right Derecho
- D44** Divider Separador

**DISPOSABLE CONTAINER SUPPORT  
APOYO CONTENEDOR DESECHABLE**

Max. 10 litres 10 litros  
Epoxy painted steel Acero pintado epoxi



- 33L** Left Izquierdo
- 33R** Right Derecho

**BACK SIDE ACCESSORIES ACCESORIOS PARTE POSTERIOR**

**BACK FIXING RAIL  
RIEL DE FIJACIÓN POSTERIOR**

☒ 25 x 10 mm Max. 20 kg  
Stainless steel Acero inoxidable



**37QT** Square Cuadrado  
**37T** Simple

**CPR BOARD  
TABLA RCP  
(REANIMACIÓN CARDIOPULMONAR)**



Dimensions Dimensiones 660 x 440 mm



**34**

**ELECTRICAL CONNECTION BASE  
BASE DE CONEXIÓN ELÉCTRICA**



3 metres cable Cable 3 metros  
Integrated cable support Recogecables integrado



**38EU** SCHUKO, type F Tipo F  
**38US** USA, type B Tipo B  
**38UK** UK, type G Tipo G  
**38CH** Switzerland, type J Suiza, tipo J

## ACCESSORIES ACCESORIOS

### LAPTOP BASE BASE PARA ORDENADOR PORTÁTIL

Left side assembly  
Rotating and tilting base  
Padlock with security cable

Montaje lado izquierdo  
Base giratoria y basculante  
Candado con cable de fijación  
Width Anchura 398 - 308 mm Depth Profundidad 270 mm



**27**



**27EV** Assembly in elevated accessory  
Montaje en accesorio elevado

### ROTATING ARM FOR DEFIBRILLATOR BRAZO GIRATORIO PARA DESFIBRILADOR

Right side assembly Montaje lado derecho  
Two rotation axles Dos ejes de giro  
Useful dimensions Dimensiones útiles 350 x 350 mm  
Fixing strap Correa de fijación  
Max. 8 kg



**28**



**28EV** Assembly in elevated accessory  
Montaje en accesorio elevado

**ACCESSORIES ACCESORIOS**

**GEL DISPENSER  
DISPENSADOR DE GEL**

500 ml rechargeable jar  
Bote recargable 500 ml



**48L** Left Izquierdo  
**48R** Right Derecho

**DRIP TRAY  
BANDEJA DE GOTEO**

Manually removable  
Desmontable manualmente



**GT**



**48Q** Square trolley Carro cuadrado  
Assembly Montaje en RA5Q, RA4Q



**48** Right side assembly in elevated accesory  
Montaje lado derecho en accesorio elevado



**ACCESSORIES ACCESORIOS**

**HANGER SUPPORT  
SOPORTE COLGADOR**

Max. 6 kg



58

**SERUM HOLDER  
PORTASUEROS** **CE**

Stainless steel Acero inoxidable  
Max. 4 kg  
Adjustable height Altura regulable



40

**ELEVATED HANGER SUPPORT  
SOPORTE COLGADOR ELEVADO** **CE**

Stainless steel Acero inoxidable  
Max. 4 kg  
For serum preparation Para preparación de sueros



41

## ACCESSORIES ACCESORIOS

### GLASS DISPENSER DISPENSADOR DE VASOS

For glasses of Para vasos de 150, 200, 220 ml  
Max. 70 glasses 70 vasos



- 47L** Left Izquierdo
- 47R** Right Derecho
- 47** Left side assembly in elevated accessory  
Montaje lado izquierdo en accesorio elevado

### CABLE LEAD GUIDE SUPPORT APOYO GUÍA CABLES

Stainless steel Acero inoxidable



**42**

### 2 ENDOSCOPES SUPPORT SOPORTE PARA 2 ENDOSCOPIOS

Stainless steel Acero inoxidable  
Adjustable height Altura regulable



- 45L** Left Izquierdo
- 45R** Right Derecho

### ENDOSCOPE DISINFECTION JAR BOTE PARA DESINFECCIÓN DEL ENDOSCOPIO

500 ml



- 66L** Left Izquierdo
- 66R** Right Derecho

**ISO FURNITURE ACCESSORIES ACCESORIOS PARA MOBILIARIO ISO**

**ADJUSTABLE SHELF FOR CATHETERS  
BANDEJA REGULABLE PARA CATÉTERES**

25 hooks 25 colgadores



**60CAT**

**ADJUSTABLE SHELF  
BANDEJA REGULABLE**

Phenolic Fenólico Max. 22 kg



**60** 600 x 440 mm - Mod. 606

**62** 400 x 610 mm - Mod. 620

**ADJUSTABLE SHELF DIVIDER  
SEPARADOR BANDEJA REGULABLE**

Epoxy painted steel Acero pintado epoxi



**DV**

**RETENTION STOP  
TOPE DE RETENCIÓN**

1 set per drawer 1 juego por cajón



**TR**

**LOCK STOP SET  
CONJUNTO DE TOPES DE BLOQUEO**

1 set per trolley 1 conjunto por carro



Lock the guides of the ISO panel that are not used  
Bloquean las guías del panel ISO que no se usan

**TP**

**ISO FURNITURE ACCESSORIES ACCESORIOS PARA MOBILIARIO ISO**  
**600 x 400 mm ISO DRAWERS CAJONES ISO 600 x 400 mm**

**ISO DRAWER LID TAPA CAJÓN ISO**



**LD** 2 holes for seals  
 2 agujeros para precintos

**50 mm ISO DRAWER (8 litres)**  
**CAJÓN ISO 50 mm (8 litros)**



**71**  
**71LD** 2 holes for seals  
 2 agujeros para precintos

**100 mm ISO DRAWER (19 litres)**  
**CAJÓN ISO 100 mm (19 litros)**



**72**  
**72LD** 2 holes for seals  
 2 agujeros para precintos

**100 mm ISO CLOSED DRAWER (19 litres)**  
**CAJÓN ISO CERRADO 100 mm (19 litros)**



**72C**  
**72CLD** 2 holes for seals  
 2 agujeros para precintos

**200 mm ISO DRAWER (33 litres)**  
**CAJÓN ISO 200 mm (33 litros)**



**73**  
**73LD** 2 holes for seals  
 2 agujeros para precintos

**240 mm HIGH ISO DRAWER**  
**CAJÓN ISO ALTURA 240 mm**



**73BT** Loose drawer unit Cajón suelto  
**AX73.73BT** Mounted on trolley  
 Montado en carro

## ELEVATED ACCESSORIES ACCESORIOS ELEVADOS

### MONITOR SUPPORT SOPORTE PARA MONITOR

3 Positions, adjustable

3 Posiciones, regulable

VESA 75 / 100 mm

Epoxy painted steel Acero pintado epoxi



**26M(R75QM)** Square Cuadrado

**26M(R75M)** Simple



### TABLET SUPPORT SOPORTE PARA TABLETA

Variable height Altura variable

Width Anchura 150 - 195 mm

Tablets from 7" to 12" Tabletillas desde 7" a 12"



**63L** Left Izquierdo

**63R** Right Derecho

**63** Assembly in elevated accessory  
Montaje en accesorio elevado

### MONITOR ARTICULATED ARM BRAZO ARTICULADO PARA MONITOR

Two rotation axes Dos ejes de giro

VESA 75 / 100 mm

Max. 9,5 kg



**76** Assembly in elevated accessory  
Montaje en accesorio elevado

**76L** Left Izquierdo

**76R** Right Derecho

**ELEVATED ACCESSORIES ACCESORIOS ELEVADOS**

**ELEVATED TUBE SET  
JUEGO TUBOS ELEVADOS**



**BINS DISPENSER  
DISPENSADOR DE CAJITAS**



**RA5Q** Square Cuadrado  
**RA5** Simple  
**RA5N** Double Doble

**RA4Q** Square Cuadrado  
**RA4** Simple  
**RA4N** Double Doble

**CENTRAL SUPPORT  
SOPORTE CENTRAL**

Epoxy painted steel  
Acero pintado epoxi  
Depth Profundidad 150 mm  
Max. 22 kg

**CENTRAL SHELF  
ESTANTE CENTRAL**

Epoxy painted steel  
Acero pintado epoxi  
Depth Profundidad 230 mm  
Max. 22 kg

**CENTRAL RAIL  
RIEL CENTRAL**

Stainless steel Acero inoxidable  
25 x 10 mm  
Max. 15 kg



**R1Q** Square Cuadrado  
**R1** Simple  
**R1N** Double Doble

**R2Q** Square Cuadrado  
**R2** Simple  
**R2N** Double Doble

**R7Q** Square Cuadrado  
**R7** Simple  
**R7N** Double Doble

**ELEVATED ACCESSORIES ACCESORIOS ELEVADOS**

**480 x 480 mm**  
**640 x 480 mm**  
**900 x 630 mm**

↑ Variable height, bridles attachment  
 ↓ Altura variable, fijación con bridas



**26LW(R1Q)** Square Cuadrado  
**26LW(R1)** Simple  
**26LW(R1N)** Double Doble



**26LW(R2Q)** Square Cuadrado  
**26LW(R2)** Simple  
**26LW(R2N)** Double Doble



**26LW(R7Q)** Square Cuadrado  
**26LW(R7)** Simple  
**26LW(R7N)** Double Doble

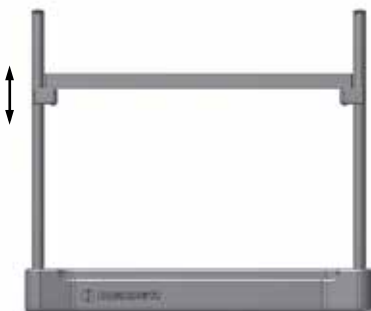

**26(R7Q)** Square Cuadrado  
**26(R7)** Simple  
**26(R7N)** Double Doble



**26(R1Q.R1Q)** Square Cuadrado  
**26(R1.R1)** Simple  
**26(R1N.R1N)** Double Doble



**26(R2Q.R2Q)** Square Cuadrado  
**26(R2.R2)** Simple  
**26(R2N.R2N)** Double Doble



**26(R7Q.R7Q)** Square Cuadrado  
**26(R7.R7)** Simple  
**26(R7N.R7N)** Double Doble



**26(R2Q.R1Q)** Square Cuadrado  
**26(R2.R1)** Simple  
**26(R2N.R1N)** Double Doble



**26(R2Q.R7Q)** Square Cuadrado  
**26(R2.R7)** Simple  
**26(R2N.R7N)** Double Doble

**ELEVATED ACCESSORIES ACCESORIOS ELEVADOS**

**480 x 480 mm  
640 x 480 mm**

↑ Variable height, bridles attachment  
↓ Altura variable, fijación con bridas

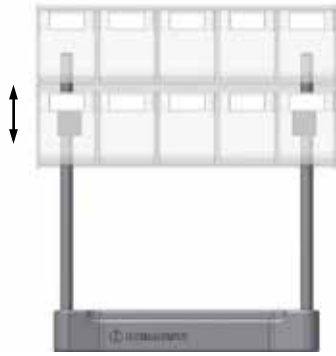

**26(RA5Q.A5)** Square Cuadrado  
**26(RA4Q.A5)** Square Cuadrado

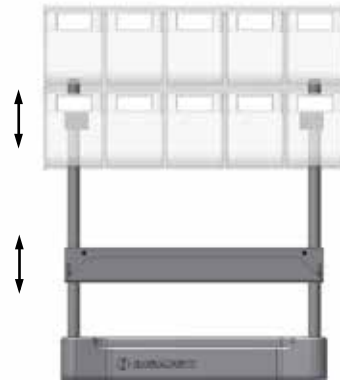

**26(RA5Q.A5.R1Q)** Square Cuadrado  
**26(RA4Q.A5.R1Q)** Square Cuadrado



**26(RA5Q.A5.R2Q)** Square Cuadrado  
**26(RA4Q.A5.R2Q)** Square Cuadrado



**26(RA5.A5)** Simple

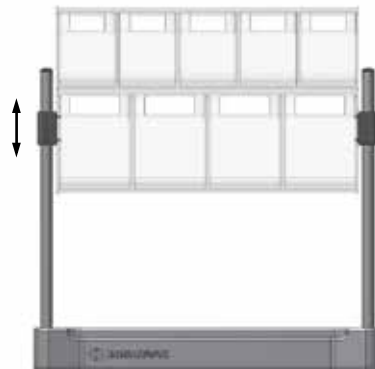

**26(RA4.A5)** Simple



**26(RA5.A5.R1)** Simple



**26(RA4.A5.R1)** Simple



**26(RA5.A5.R2)** Simple



**26(RA4.A5.R2)** Simple



↑ Variable height, bridles attachment  
 ↓ Altura variable, fijación con bridas

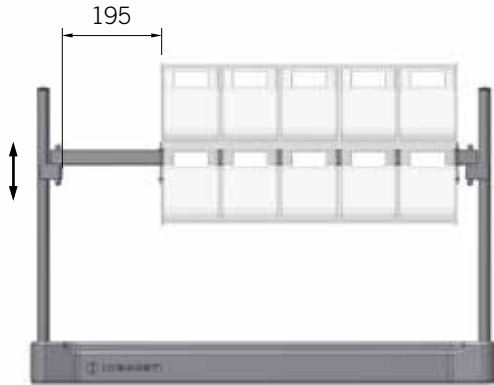

**26(RA5N.A5)** Double Doble

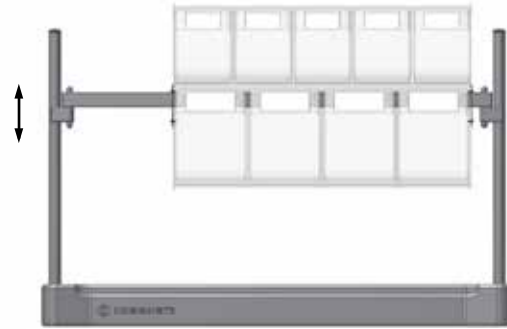

**26(RA4N.A5)** Double Doble

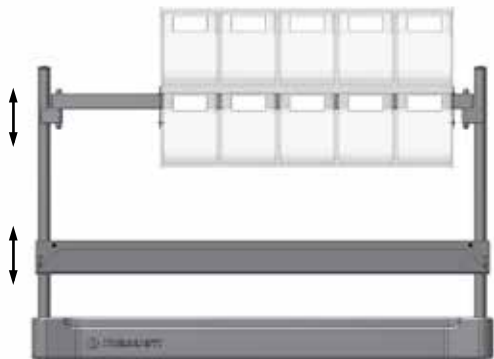

**26(RA5N.A5.R1N)** Double Doble

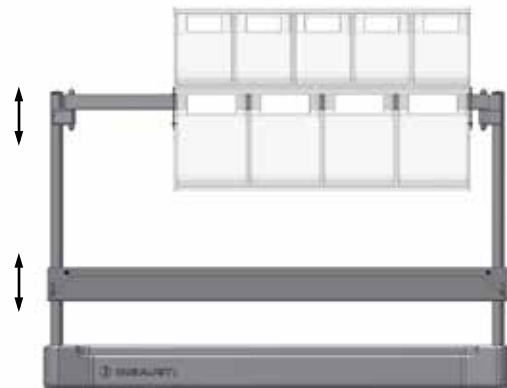

**26(RA4N.A5.R1N)** Double Doble

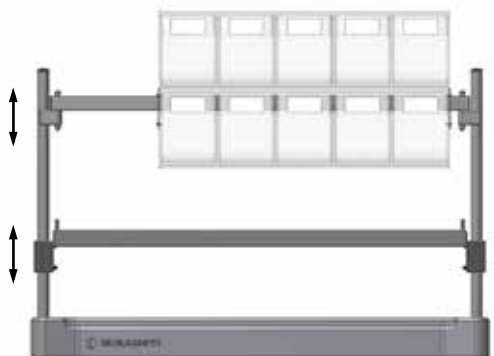

**26(RA5N.A5.R2N)** Double Doble

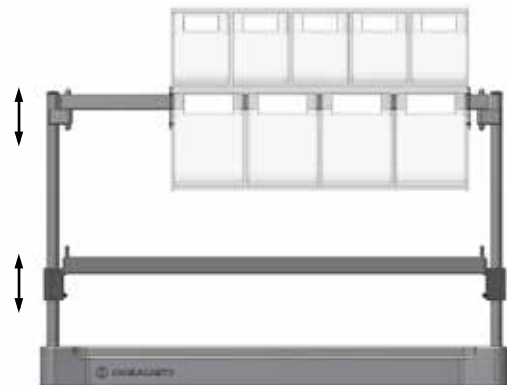

**26(RA4N.A5.R2N)** Double Doble



Since Desde  
**1991**



All articles with EC mark are considered as medical device class I and follow regulation (EU) 2017/745

Todos los artículos con la marca CE se consideran producto sanitario de clase I y siguen el reglamento (UE) 2017/745

Guarantee period:

5 years

3 years drawers slides of the medical trolleys

Periodo de garantía:

5 años

3 años correderas de los cajones de los carros médicos

INSAUSTI reserves the right to make modifications

INSAUSTI se reserva el derecho a modificaciones

Photographs taken at the San Juan de Dios Hospital in Pamplona

Fotografías realizadas en Hospital San Juan de Dios de Pamplona



Designed and manufactured in Spain

Diseñado y fabricado en España



**strack** Patienten-  
und Pflegebedarf

Strack AG                      052 630 31 60  
Ebnatstrasse 125            www.strack.ch  
8200 Schaffhausen        info@strack.ch



**2022**